

25. ボイラー後部1

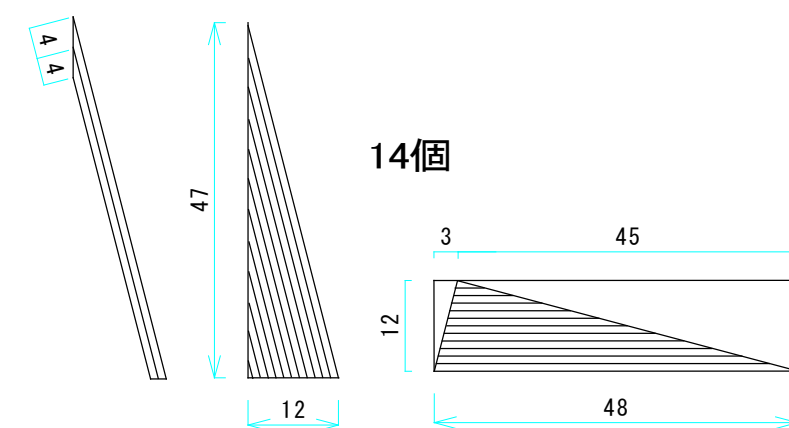
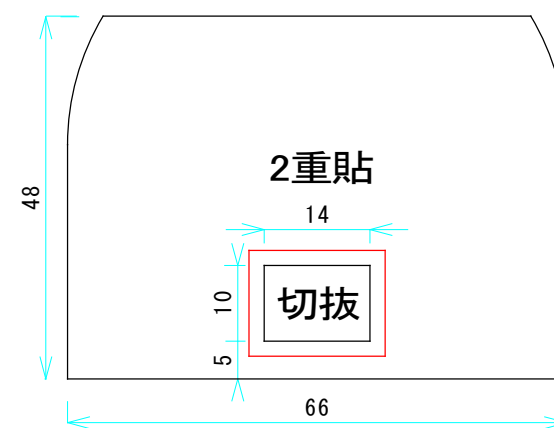
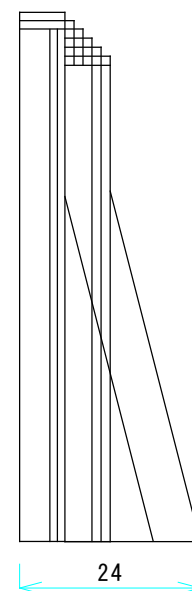
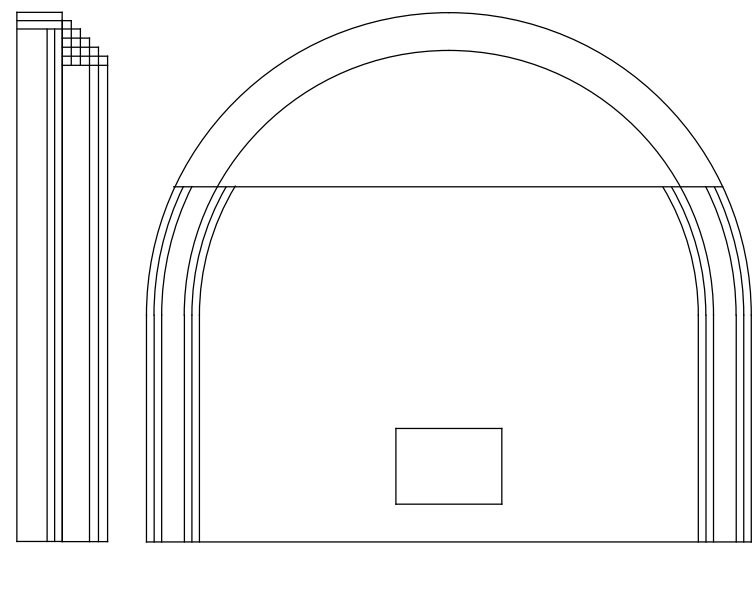
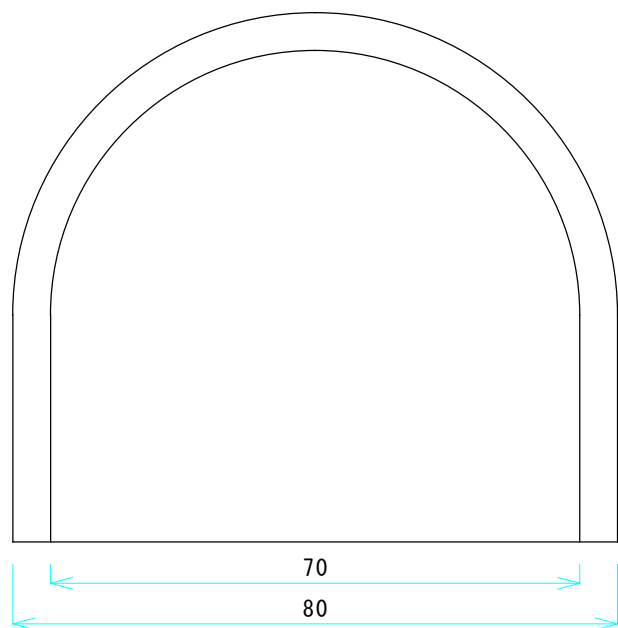
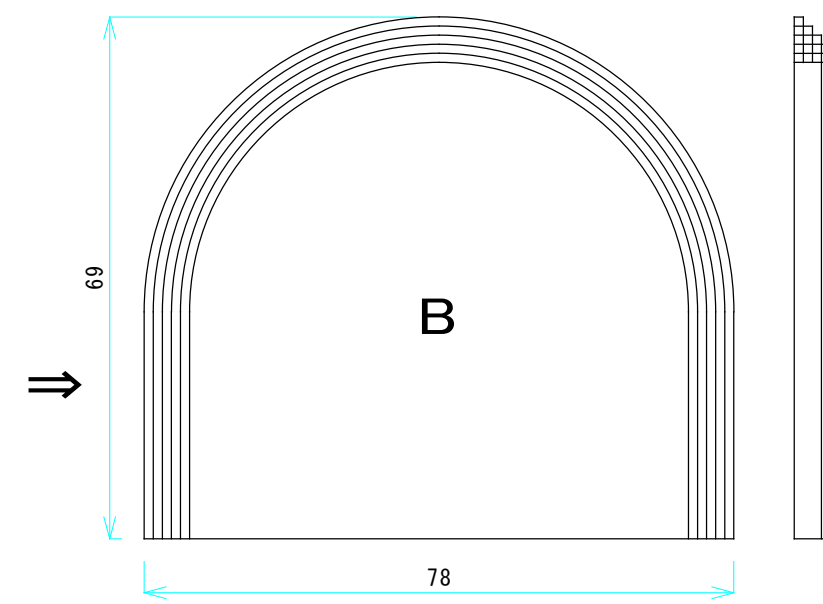
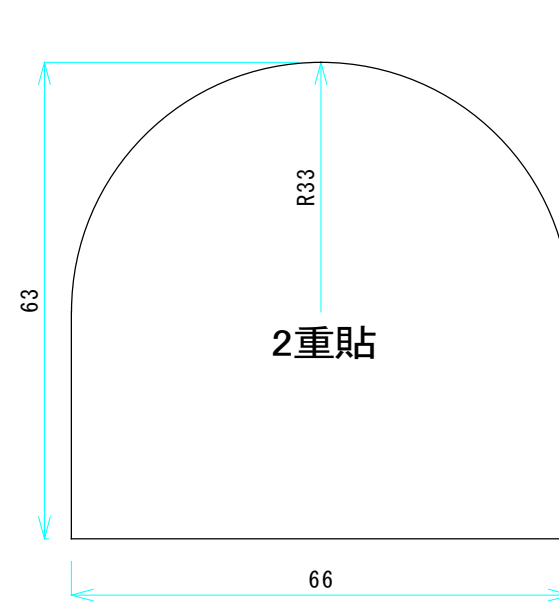
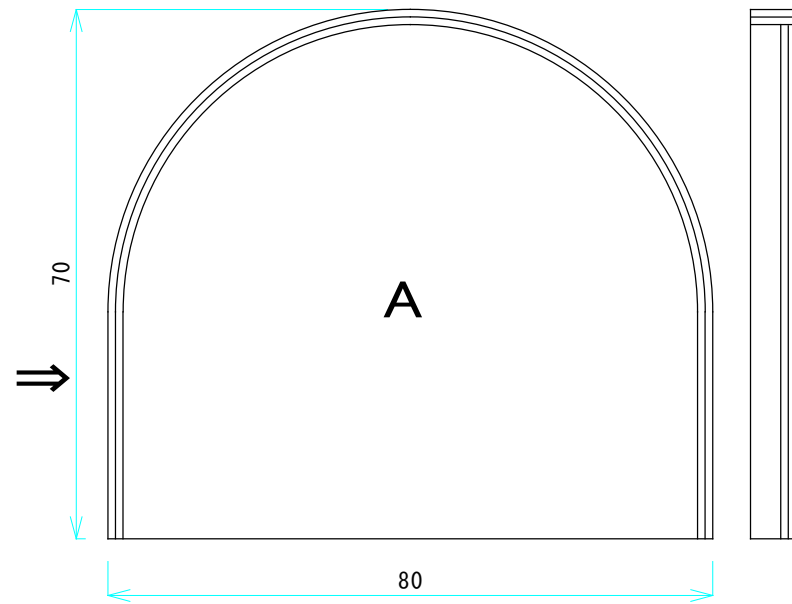
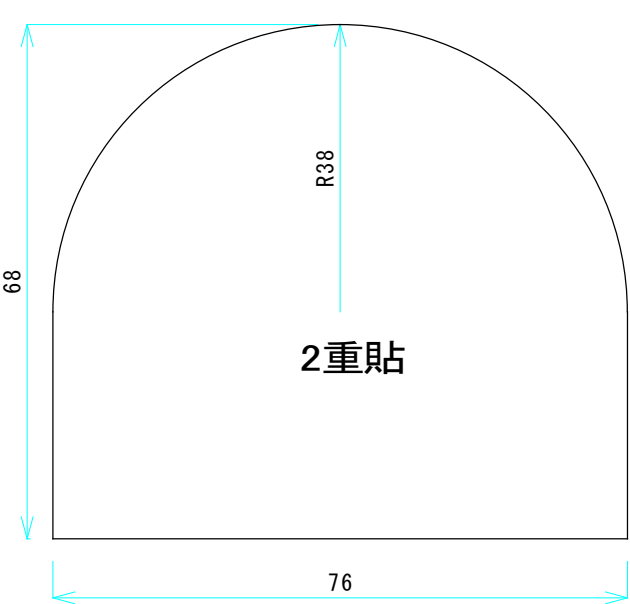

AとBを貼り合わせる

パイプはアクリル丸棒1mm銅色

切り抜いた裏側に接着

